

The Amica logo consists of the word "Amica" in a white, sans-serif font, centered within a red rounded rectangle.

Amica

ADV 7C LCW

OPERATING INSTRUCTIONS

DRYER

Please carefully read these Operating Instructions before using the appliance!

IO-WMS-0020
(11.2022/1)

CONTENTS

Basic Information.....	3
Safety instructions.....	4
Installing the dryer.....	7
Understanding the symbols on clothes labels.....	10
Display and control panel.....	11
Using the appliance.....	14
Table of programmes.....	15
Troubleshooting.....	16
Maintenance and Cleaning.....	17
Safety Reset.....	18
Specification.....	19
Service and Warranty.....	19



In accordance with European Directive **2012/19/EC** and Polish legislation regarding used electrical and electronic goods, this appliance is marked with the symbol of the crossed-out waste container.

This marking indicates that the appliance must not be disposed of together with other household waste after it has been used.

The user is obliged to hand it over to waste collection centre collecting used electrical and electronic goods. The collectors, including local collection points, shops and local authority departments provide recycling schemes. Proper handling of used electrical and electronic goods helps avoid environmental and health hazards resulting from the presence of dangerous components and the inappropriate storage and processing of such goods.

BASIC INFORMATION

Dear customer,

From today, DRYING will be easier than ever before. Your Amica DRYER is exceptionally easy to use and extremely efficient. After reading these Operating Instructions, operating the appliance will be easy.

Before being packaged and leaving the manufacturer, the appliance was thoroughly checked with regard to safety and functionality. After these tests some moisture or water may remain in the appliance.

Before using the appliance, please carefully read these Operating Instructions

By following these instructions carefully you will be able to avoid any problems in using the appliance.

It is important to keep these Operating Instructions and store them in a safe place so that they can be consulted at any time.

Follow these instructions carefully in order to avoid possible accidents.



Important!

This dryer is intended for household use only for drying textiles and clothing.

Level the appliance before connecting it to a wall socket.

The manufacturer reserves the right to introduce changes, which do not affect operation of the appliance.

Use

- Carefully read the instructions below before using the appliance.
- Never use the appliance outdoors or anywhere the temperature may fall below freezing.
- The appliance should not be operated by children or anyone who has not read the instructions.

Important! Temperatures below 0°C can damage the appliance!

In the event of the appliance being stored or transported in sub-zero temperatures, it should be left to acclimatise in a temperature above 0°C for 8 hours before being used.

MANUFACTURER'S DECLARATION

This appliance has been manufactured to comply with all EU & UK statutory requirements and complies with all applicable legislation and the following European Directives:

- Low Voltage Directive **2014/35/EU**,
- Electromagnetic Compatibility (EMC) Directive **2014/30/EU**,

The product has been marked with the **UK** **CA** and **CE** symbols.

NOTES ON SAFETY

- 1) Unique and luxury design: Uniquely styled front loading dryer.
- 2) Electronic Controls: Simple and convenient operation thanks to electronic controls. The appliance will automatically adjust the temperature when drying.
- 3) Large door opening: Observe the drying process clearly through the door window.
- 4) Open the door to 180°: It is very convenient to put in and take out laundry thanks to wide opening angle.
- 5) Clever design: Suitable capacity and unique appearance with anti-dust, anti-humidity, anti-vibration features to ensure long life and low noise operation.
- 6) Do not tumble dry laundry cleaned with industrial chemicals.
- 7) Regularly clean the lint filter.
- 8) Lint must not to be allowed to accumulate around the tumble dryer.
- 9) Adequate ventilation must be provided to avoid the back flow of gases into the room from appliance burning other fuels, including open fires.
- 10) Do not dry unwashed items in the tumble dryer.
- 11) Items that have been soiled with substance such as cooking oil, acetone, alcohol, petrol, kerosene, spot removers, turpentine, waxes and wax removers should be washed in hot water with a extra amount of detergent before being dried in the tumble dryer.
- 12) Items such as foam rubber (latex foam), shower caps, waterproof textiles, rubber backed articles and clothes or pillows fitted with foam rubber pads should not be dried in the tumble dryer.
- 13) Fabric softeners, or similar products, should be used as specified by the fabric softener instructions.

NOTES ON SAFETY

14) The final part of a tumble dryer cycle occurs without heat (cool down cycle) to ensure that the items are cooled down to a lower temperature and they will not be damaged.

15) **WARNING:** never stop a tumble dryer before the end of the drying cycle unless all items are quickly removed and spread out so that the heat is allowed to escape safely.

16) The exhaust air must not be discharged into a flue which is used for exhausting fumes from appliance burning gas or other fuels.

17) The appliance must not be installed behind a lockable door, a sliding door or a door with a hinge on the opposite side to that of the tumble dryer in such a way that a full opening of the tumble dryer door is restricted.

18) Oil-stained items can ignite spontaneously, especially when exposed to heat sources such as in a tumble dryer. The items become warm, causing an oxidation reaction in the oil. Oxidation creates heat. If the heat cannot escape, the items can become hot enough to catch fire. Piling, stacking or storing oil-stained items can prevent heat from escaping and so create a fire hazard.

19) If it is unavoidable that fabrics that contain vegetable or cooking oil or which have been contaminated by hair care products be placed in a tumble dryer, they should first be washed in hot water with extra detergent. This will reduce, but not eliminate, the hazard.

20) The appliance should not be tilted during normal use or maintenance.

21) Remove all objects from pockets such as lighters and matches.

NOTES ON SAFETY

22) This appliance can be used by children aged from 8 years and above and persons with reduced physical, sensory or mental capabilities or lack of experience and knowledge if they have been given supervision or instruction concerning use of the appliance in a safe way and understand the hazards involved. Children shall not play with the appliance. Cleaning and user maintenance shall not be made by children without supervision.

23) For appliances with ventilation openings in the base, carpet must not obstruct the openings.

24) If the power cord is damaged, it must be replaced by the manufacturer, its service agent or similarly qualified persons in order to avoid a hazard.

25) This appliance is for indoor use only.

26) The openings must not be obstructed by a carpet.

27) Children of less than 3 years should be kept away unless continuously supervised.

INSTALL THE DRYER

I. Position and level the appliance



- For convenience, it is recommended to place the appliance near a washing machine.
- Do not place the appliance on a carpet!
- The dryer must be installed in a clean place, where dirt does not accumulate. There must be free air circulation around the appliance. Do not block the front air inlet or air intake grilles at the back of the appliance.
- The floor surface should not be either concave or sloping!
- Pay attention to the shape of the floor surface, and make sure the entire appliance weight rests on its legs (not its body)!

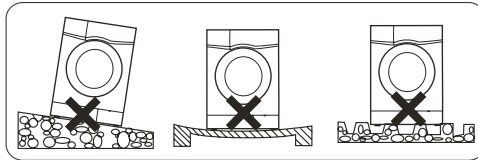

- Place the appliance on a solid, even surface.
- Level the machine by adjusting the legs (1)



After positioning and levelling the appliance, check that it is stable by pressing down each corner and ensuring it does not move!

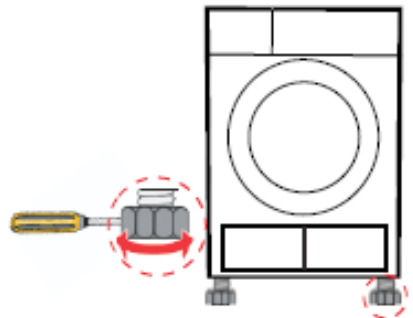

INSTALL THE DRYER

II. Connect to power supply

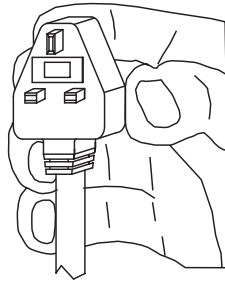
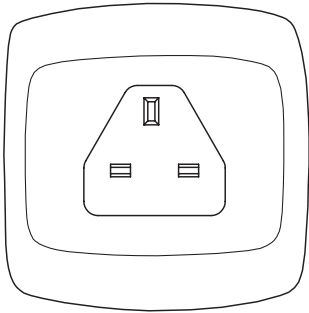











- The appliance's mains connection (electrical wall socket) should be in a visible and accessible place!
- Only plug the appliance into a properly installed socket with an earth pin!
- Do not connect the appliance through any extension cord or an adapter!
- In the event of the power cord being damaged, it must be replaced by an authorised technician.
- The electrical system to which the appliance is to be connected must be protected with a 13 A fuse.

INSTALL THE DRYER













III. Tips

1. Before drying, thoroughly spin the laundry in washing machine. High spin speed can the drying time and save energy consumption.
2. For uniform drying result, sort the laundry according to fabric type and drying programme.
3. Before drying, please close zips, hooks and eyelets, button up, tie fabric belts, etc.
4. Do not over dry the clothes, because over dried clothes can easily get creases.
5. Do not dry the articles containing rubber or similar elastic materials.
6. Do not open the dryer door when in operation, as steam or hot dryer may cause skin burns.
7. Clean the lint filter and empty container after each use to avoid extension of drying time and energy use.
8. Do not dry these clothes after dry-clean process.

Coats (approx. 800 g) 	Jackets (about 800g cotton) 	Jeans (approx. 800 g) 	Quilts (about 900g cotton) 
Sheets (about 600g cotton) 	Working clothes (upper and lower) (about 1120g cotton) 	Pyjamas (approx. 200g) 	Shirts (about 300g cotton) 
T-shirts (about 180g cotton) 	Briefs, panties (about 70g cotton) 	Socks (about 30g fiber mix) 	

UNDERSTANDING THE SYMBOLS ON CLOTHES LABELS

Before drying pay attention to the symbols on the apparel label.
 Failure to follow the symbol instructions may damage or destroy clothes to be dried.
 The symbols are explained in the following table:

 Dry	 Normal	 Not tumble dry normal	 Do not dry
 Line dry / hang to dry	 Drip dry	 Dry flat	 In the shade
 Dry clean	 Do not dry clean	 Dry clean normal cycle with any solvent	 Dry clean normal cycle petroleum solvent only

Dryer description

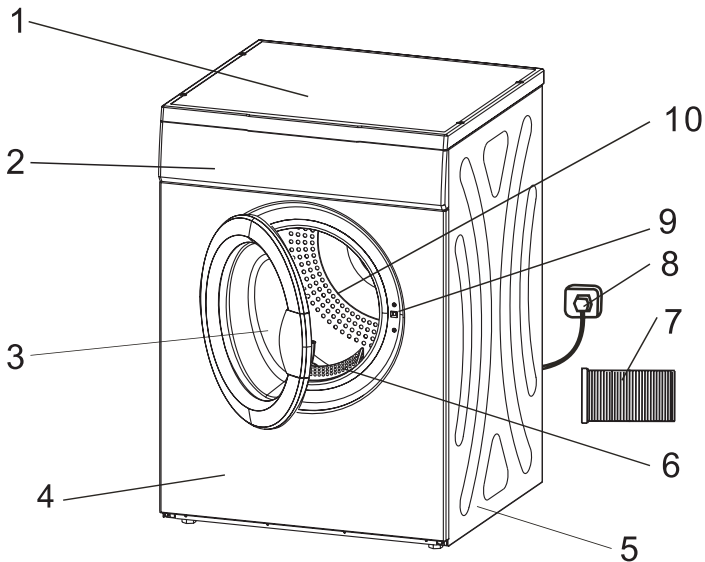

- | | |
|------------------|---------------|
| 1. Top board | 6. Filter |
| 2. Control panel | 7. Flex tube |
| 3. Door | 8. Power plug |
| 4. Front panel | 9. Switch |
| 5. Side panel | 10. Drum |

DISPLAY AND CONTROL PANEL

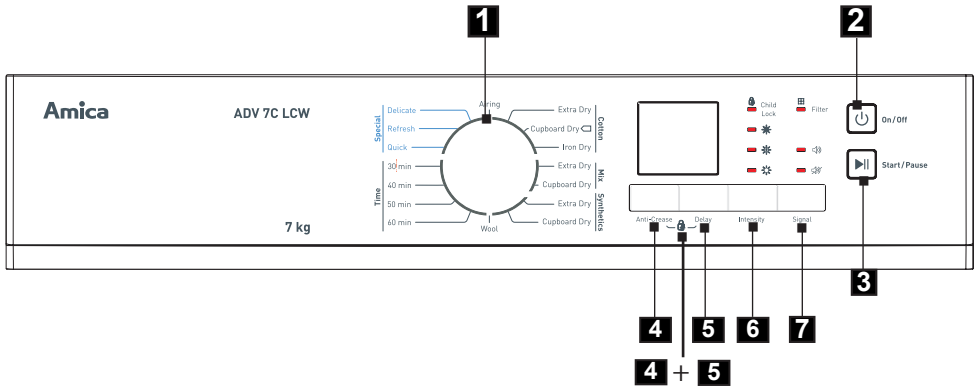

1. Programme selector dial
2. **On/Off** button
3. **Start/Pause** button
4. **Anti-Crease** button
5. **Delay** button
6. **Intensity** button
7. **Signal** button
- 4 + 5. **Child Lock**

DISPLAY AND CONTROL PANEL

Programme selector dial

Choose the appropriate drying programme as required, depending on the type and amount of laundry loaded, which ensures better results and more effective drying. Once the drying programme is started, turning the programme selector knob to another position is possible, however it does not change the previously selected programme.

Press the **Signal** button to select the on or off signal function. The buzzer will prompt from the dryer when finishing the cycle. Press the **On/Off** button and pull out the power cable.

START/PAUSE button

Press **Start/Pause** to start or pause a programme.

During the drying cycle the corresponding drying programme phase symbol is displayed. When **Paused**, the symbols are lit. You can use **Pause** to add laundry for drying.

Anti-Crease button

Once the programme has ended, the Anti-crease function operates for 30 minutes (default) or 120 minutes (when selected).

When you select the [Anti-Crease] function its indicator will come on. This feature prevents creases in clothing. The laundry can be removed during this phase except in the [Cool], [Refresh] and [Wool] programmes.

This function can be selected in all programs.

When the anti-crease function is selected, the drum will intermittently rotate during the drying programme to ensure that sensitive textiles do not crease.

When no one removes the laundry after the programme is finished, the dryer will automatically intermittently rotate the drum for about 2 hours to avoid creasing.

Delay Start button



Press this button to set the delay time for starting programme. The setting range available is from 1-24 hours. Press the button to set the time after which drying is to commence.

NOTE: If there is a power outage during Delay Time, countdown will NOT resume immediately after the power is restored. You must re-set the programme and the delay start option.

DISPLAY AND CONTROL PANEL

Intensity button



Use this function to adjust clothes drying intensity. There are three intensities

Drying intensity:   

The drying time is extended by 3 minutes for each higher intensity.

The drying intensity can only be set before the start of the programme.

Press the **Intensity** button repeatedly to select the drying time.

	Intense drying
	Medium drying
	Normal drying

Signal button

By default the acoustic signal is on. Press the button to turn on/off the acoustic signal.

If the acoustic signal is on:

(A) The dryer will beep when you press an additional programme feature button.

(B) When you turn the programme selection dial during the drying cycle the appliance will beep to remind you it is not allowed choice.

(C) The appliance will beep when the drying programme has ended.

4 + 5. Child Lock

This function prevents children from changing settings or interrupting appliance

operation. Pres and hold **Anti-Crease** and **Delay button** for 3 seconds to activate the Child Lock during a drying cycle. When child lock function is set, the display will show

[] icon and only [On/Off] button can be used. To disable Child Lock, press and hold Acoustic signal and **Anti-Crease** buttons for 3 seconds.

Important! If the Child Lock function is activated, the display will show the [] symbol.

Important! When you turn off or unplug the dryer or the drying cycle ends, the Child Lock function will deactivate.

USING THE APPLIANCE

I. Select Programme

1. Press [On / Off]. When the LED display lights up turn the programme selection dial and select the desired programme
2. Select the additional option [Anti-Crease], [Delay], [Intensity] or [Signal] — if the programme allows you to select additional options.
3. Press the [Start/ Pause] button

II. Set Delay Start

The delayed start function may be used when, for example, taking advantage of discounted electricity tariffs.

Procedure:

1. Close the appliance door.
2. Set the programme selector knob to the desired programme (see the table further on).
3. Select additional functions or drying cycle parameters as required.
4. Press the Delay Start button.
5. Select time ranging from 1 to 24 hours. The display will show the setting from 1H to 24H.
6. Press the [Start/ Pause] button. The appliance will be set in delay mode. Drying cycle will commence immediately after the delay time has elapsed.

Note: If you set delay start, the display will show the time remaining to start the drying program.

III. End of drying cycle

1. Once the programme has completed, the drum stops rotating and the display shows "0:00". The last programme phase indicator will flash. If you do not remove clothes from the dryer with a specified time, the appliance will start the [Anti-Crease] programme. Press [On/Off] and remove the plug from the wall outlet.
2. If the appliance suddenly stops during the drying programme and displays an error message, follow the information in the "Troubleshooting" section.

IV. Cancel or modify programme

Press the On/Off button to interrupt the programme. Then press on/off button again to turn on the appliance and select the desired drying programme.

TABLE OF PROGRAMMES

	Programme name	Weight (Max) kg	Additional functions available			Recommendations	Time [H:min]	Energy consumption [kWh]	
			Delay	Intensity	Anti-Crease				
Cotton	Extra Dry	7	Option	Option	Option	To dry cotton pieces of clothing. Drying level: less dry.	2:30	4,77	
		3,5					1:30	2,82	
	Standard (Cupboard dry) 	7		Option	Option		2:20	4,44	
		3,5					1:15	2,34	
	Iron Dry	7		Option	Option		1:50	3,64	
		3,5					1:05	2,01	
MIX	Extra Dry	7	Option	Option	To dry mix pieces of clothing. Drying level: extra dry.	2:55	5,10		
		3,5				1:30	2,82		
	Standard (Cupboard dry)	7		Option		Option	To dry mix pieces of clothing. Drying level: standard dry.	2:45	4,70
		3,5					1:30	2,82	
Synthetics	Extra Dry	3	Option	Option	To dry synthetics pieces of clothing. Drying level: extra dry.	0:57	1,85		
		1				1:00	1,85		
	Standard (Cupboard dry)	3		Option		Option	To dry synthetics pieces of clothing. Drying level: standard dry.	0:47	1,52
		1					0:50	1,52	
Time	30 min	-	Option	-	Option	Time 30 min.	0:30	0,90	
	40 min					Time 40 min.	0:40	1,20	
	50 min					Time 50 min.	0:50	1,50	
	60 min					Time 60 min.	1:00	1,90	
Special	Delicate	-	Option	Option	Option	To dry delicate laundry that is suitable for drying or laundry which is advised to be hand-washed at a lower temperature.	0:18	0,45	
		Refresh				Remove the smell for the long-laid clothes.	0:20	0,15	
		Quick				Rapid warm for the long-laid clothes.	0:23	0,70	
Airing	Airing	-	Option	-	Option	To air clothes without blowing hot air.	0:20	0,07	
Wool	Wool	-	Option	-	Option	For a fluffy and fresh wool clothing (Can not be used for drying wool clothing). When the cycle is done, take out the clothes at once, let them dry in the air.	0:08	0,11	

Note: 1. [] This symbol indicates a programme used to determine the energy efficiency of the "standard cotton fabrics drying programme", which is suitable for drying cotton fabrics at normal humidity level. It is the most energy efficient cotton drying programme.

Note: 2. Recommended applications of these programmes are indicative only. The user can select the desired program, according to own preferences. Thick and multi-layered fabrics, eg. linens, jeans and denim clothing, are difficult to dry. Actual time and energy consumption will depend on how the appliance is used.

TROUBLESHOOTING

Problem	Probable cause/Solution
No information on the display	<ul style="list-style-type: none">- Make sure the plug is properly inserted into the wall outlet.- Check the main power supply.
The dryer does not start	<ul style="list-style-type: none">- Check if the Start / Pause button is pressed.- Make sure the door is properly closed.
The door opens spontaneously	<ul style="list-style-type: none">- Push the door in until it clicks shut.- Make sure the dryer is not overloaded.
The laundry is not sufficiently dry or drying time is too long	<ul style="list-style-type: none">- Clean the top and bottom filter.- Select the appropriate programme.- Do not block the air intake.

Note:

If you can not correct the problem yourself, ask for assistance:

1. Press [On / Off].
2. Unplug the appliance and call service.

Error code	Description	Cause	Failure indication
E36	Temperature sensor error	Temperature sensor circuit is open or shorted	Programme stops and the appliance enters a fault condition

MAINTENANCE AND CLEANING

Clean the filter

1. Clean the lint filter before each use. Remove by pulling straight up.
2. Cleaning filter
Wipe the filter with a cloth.
3. Install filter
If you clean the filter with a damp cloth or wash it in the water, thoroughly dry the filter before installing.

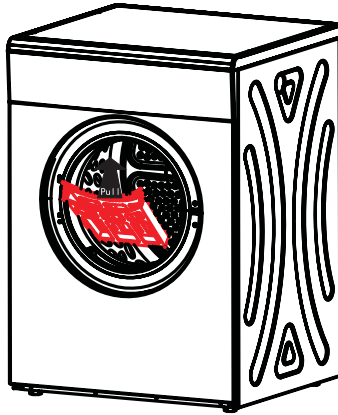

Clean the appliance body and its drum

Use a soft damp cloth to wipe the appliance body and its drum

1. Do not rinse with a direct jet of water.
2. Do not use any scouring powders to clean the appliance.
3. Do not use petrol or alcohol to wipe the appliance.

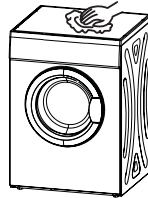

SAFETY RESET

Safety reset

1. These dryers have a temperature activated safety cut out switch.
2. The safety reset button can be found on the backboard. If your dryer does not heat you need to push this button before the dryer will operate again. You may need to wait 10 minutes for the appliance to cool down.

3. A clogged lint filter is the most common reason for the dryer to overheat.
Clean the lint filter after each drying cycle to prevent overheating.

It is will only be necessary to press the safety reset button if the dryer does not heat. Allow at least 10 minutes for the dryer to cool down before you press the button. Press and hold the white button in until you feel a click. Cleaning the filter after each drying cycle will prevent repetitive actuation of the safety cut out switch.

The cut out switch may operate for the following reasons:

1. A clogged lint filter.
2. Exhaust outlets blocked at the back of the dryer.
3. Poor ventilation in the room -- open a window or door
4. Lightweight garment eg. handkerchief, sucked in and blocking the filter.

Safety cut out switch reset button

Use your finger or a pencil to press the button in until you feel it click.

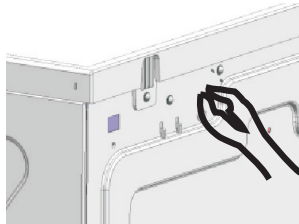

SPECIFICATION

-Type	ADV 7C LCW
- Rated voltage	220-240V / ~ 50Hz.
- Power rating [W]	2000 W
- Power of heating element/compressor [W]	1800 W
- Power of motor [W]	110 W
- Energy Efficiency Index (EEI):	84,9
- Ambient temperature	+ 5°C ~+ 35°C
- Maximum Load	max 7 kg
- Dimensions Height x Depth x Width	840/595/550 [mm]
- Weight	33 kg
Meets the requirements of EU legislation, EN- 61121 standard	

Note:

1. Rated load is a maximum load. Make sure that the weight of laundry in the dryer never exceeds the rated load.
2. Do not install the tumble dryer in a room where there is a risk of freezing temperature. The dryer may not work properly at temperature close to freezing.
3. Risk of damage if the condensed water freezes in the pump, hose or condensed water container.

Testing for label information in accordance with EN 61121 using the standard cotton drying programmes:

- at full load

- at partial load

- weighted average electricity consumption is **520 kWh/year**

Amica

 Service Help Line

For the UK: please call
01949 862012

For Ireland: please call
0818 46 46 46 (non-geographic number)
or **01 88 2010** (standard rate call)